

HARLEY DAVIDSON SPORTSTER XL 1200X '15-H

M O U N T I N G I N S T R U C T I O N S

REF 21056

SEMIFAIRING BATWING SML TOURING



En las revisiones del vehículo es conveniente efectuar también el mantenimiento de apriete de toda la tornillería del semicarenado, especialmente los tornillos que fijan éste al vehículo. **Gracias por su atención.**
It would be convenient to retighten the semifairing screws, specially the ones that are fixed to the motorcycle, whenever you maintain the vehicle. **Thanks for your attention.**

ID	PIEZA/PART	DESCRIPCIÓN	DESCRIPTION	QTY	REF
1		Semicarenado	Semifairing	1	10897N
2		Cúpula Touring	Touring screen	1	10900
3		Soporte izquierdo superior	Upper left support	1	SOP4P3SLBTM0013
4		Soporte derecho superior	Upper right support	1	SOP4P3SRBTM0013
5		Soporte izquierdo inferior	Lower left support	1	SOP4P3ILBTM0013
6		Soporte derecho inferior	Lower right support	1	SOP4P3IRBTM0013
7		Tornillo Allen ANSIB 18.3 CLASE 12.9 UNC 3/8" X 56	ANSIB 18.3 CLASE 12.9 UNC 3/8" X 56 Allen screw	6	TORNI-ANSIB-855
8		Casquillo Ø10x Ø14x 20	Ø10x Ø14x 20 bush	6	CASQUI101420299
9		Silentblock M5	M5 silentblock	4	SILENBTM5-046/1
10		Arandela nylon M5x1	M5x1 nylon washer	4	ARNV0000000245
11		Tornillo Allen M5x16 Ø11 ISO 7380	M5x16 Ø11 ISO 7380 Allen screw	4	TORNI-I7380-493
12		Tapón tornillo M5 ISO 7380	M5 ISO 7380 screw cap	4	TAPON-----85
13		Tornillo Allen M4x12 ISO7380	M4x12 ISO 7380 Allen screw	3	TORNI-I7380-800
14		Arandela nylon M4x0,5	M4x0,5 nylon washer	6	ARNV00000000311
15		Tuerca autoblocante M4	M4 nut	3	TUERCAE985-0290
16		Tapón tuerca M4	M4 cap nut	3	TAPON-----91

HARLEY DAVIDSON SPORTSTER XL 1200X '15-

INSTRUCCIONES DE MONTAJE - MOUNTING INSTRUCTIONS - MONTAGEANLEITUNG

1

DISASSEMBLY
DESMONTAJE

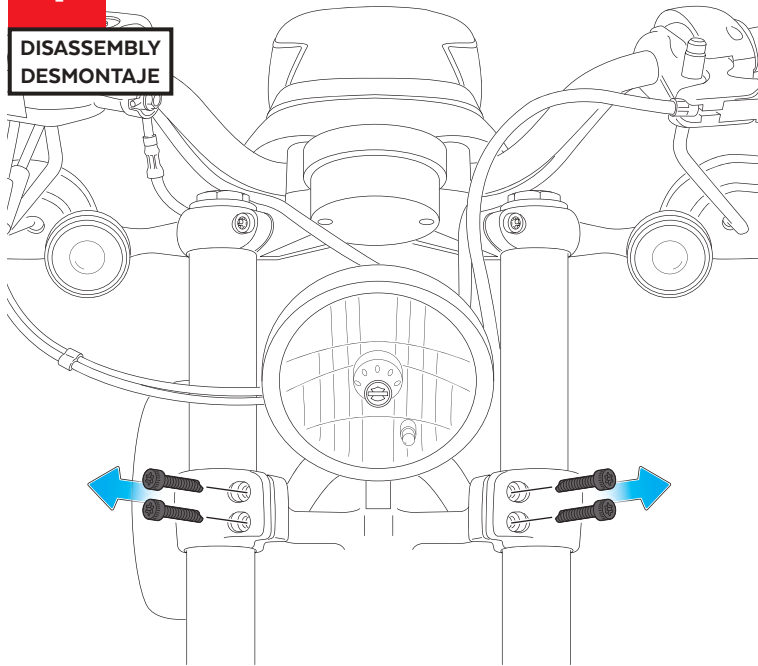

2

ASSEMBLY
MONTAJE

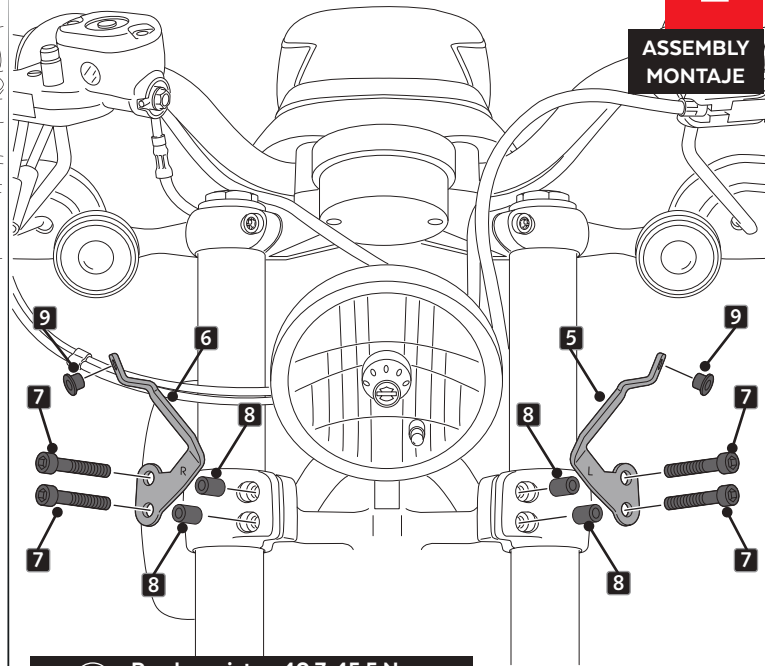

7 Par de apriete - 40,7-45,5 N.m
Tightening torque - 40,7-45,5 N.m

3

DISASSEMBLY
DESMONTAJE

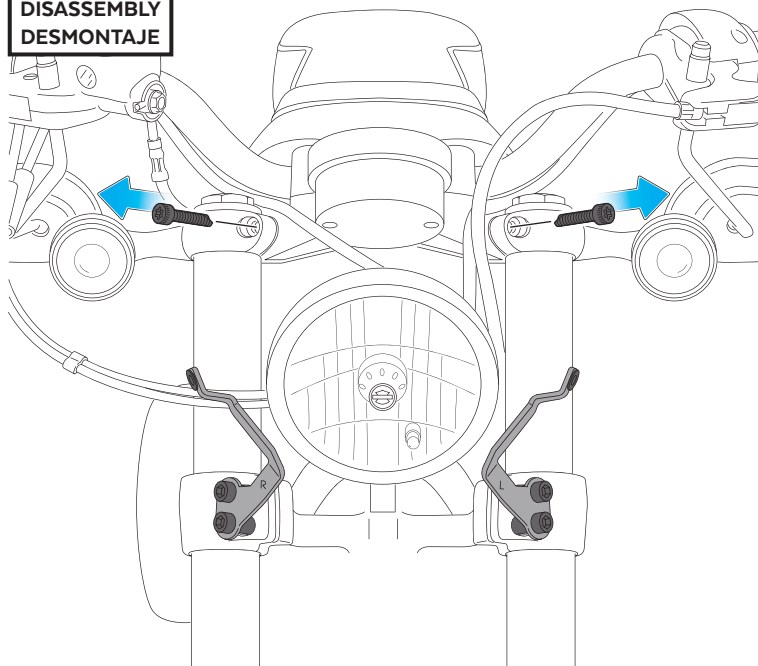

4

ASSEMBLY
MONTAJE

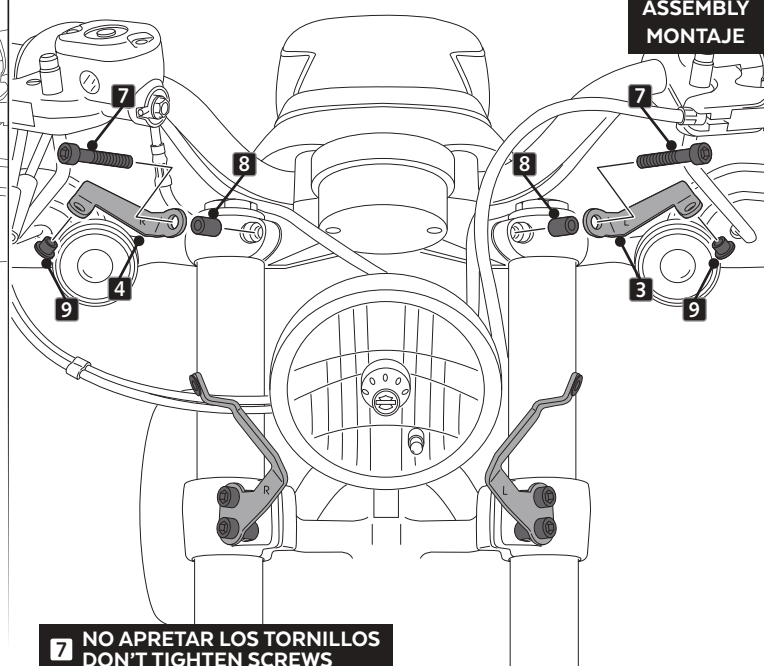

7 NO APRETAR LOS TORNILLOS
DON'T TIGHTEN SCREWS

HARLEY DAVIDSON SPORTSTER XL 1200X '15-

INSTRUCCIONES DE MONTAJE - MOUNTING INSTRUCTIONS - MONTAGEANLEITUNG

5

ASSEMBLY
MONTAJE

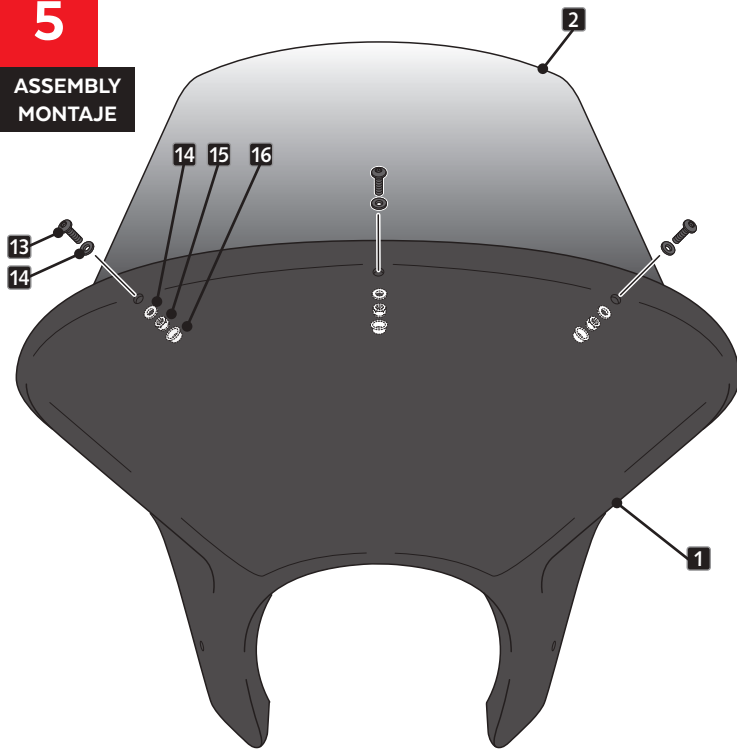

6

ASSEMBLY
MONTAJE

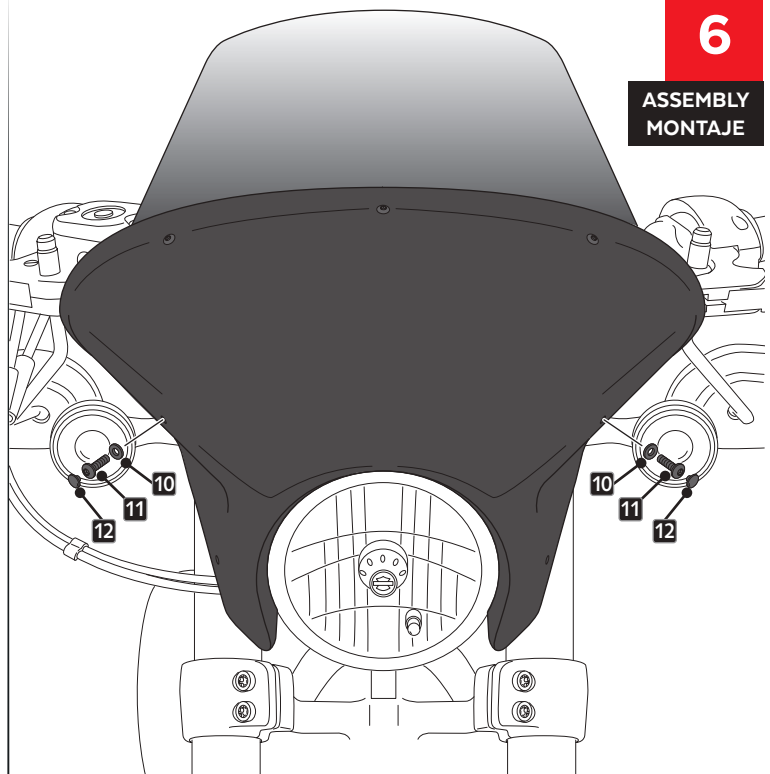

7

ASSEMBLY
MONTAJE

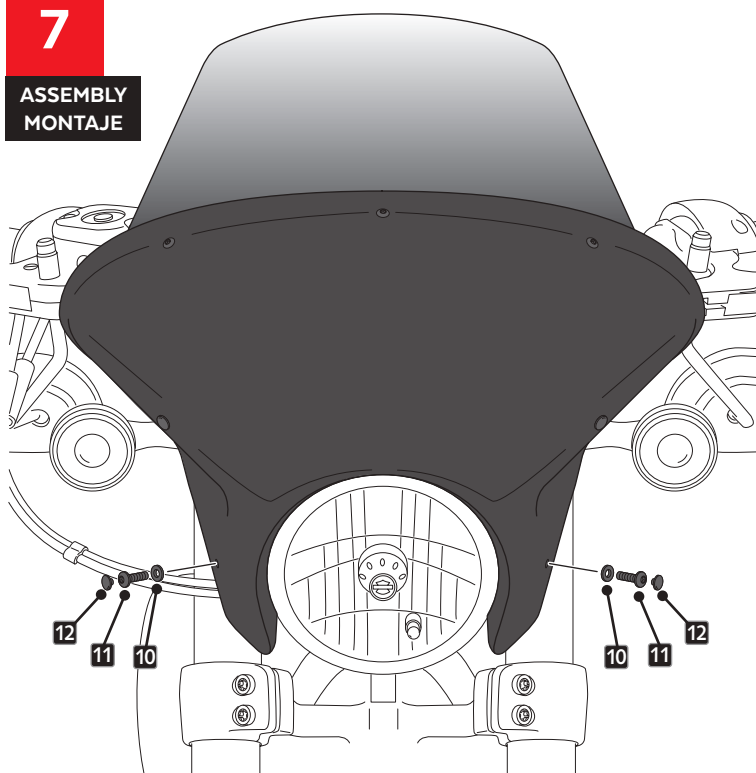

8

ASSEMBLY
MONTAJE

