

TRIUMPH BONNEVILLE SPEEDMASTER '18-

M O U N T I N G I N S T R U C T I O N S

REF 21114

SEMIFAIRING ANARCHY MODEL



1 Person



20 min



EASY











ALLEN

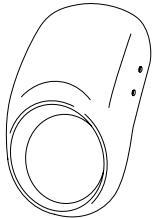

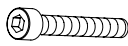
Nº 3
Nº 6



En las revisiones del vehículo es conveniente efectuar también el mantenimiento de apriete de toda la tornillería del semicarenado, especialmente los tornillos que fijan éste al vehículo. **Gracias por su atención.**
It would be convenient to retighten the semifairing screws, specially the ones that are fixed to the motorcycle, whenever you maintain the vehicle. **Thanks for your attention.**

ID.	PIEZA/PART	DESCRIPCIÓN	DESCRIPTION	QTY.	REF.:
1		Semicarenado Anarchy	Anarchy semifairing	1	10896NM3
2		Soporte derecho	Right support	1	SOP2P3-R--21114
3		Soporte izquierdo	Left support	1	SOP2P3-L--21114
4		Tornillo allen M8x45 DIN912	M8x45 DIN912 allen screw	2	TORNI-AD912-508
5		Casquillo Ø8,5x Ø13x 15	Ø8,5x Ø13x 15 arrowhead	2	CASQUI-M---614
6		Silentblock Ø9xØ6x8mm	Ø9xØ6x8mm silentblock	4	AROPASACABLES-1
7		Casquillo con valona Ø12xØ6,8x7,3	Ø12xØ6,8x7,3 bush with flange	4	CASQUI-1A---750
8		Tornillo allen M5x16 Ø11 ISO 7380	M5x16 Ø11 ISO 7380 allen screw	4	TORNI-I7380-493
9		Tapón tornillo M5 ISO 7380	M5 ISO 7380 screw cap	4	TAPON-----85

TRIUMPH BONNEVILLE SPEEDMASTER '18-

INSTRUCCIONES DE MONTAJE - MOUNTING INSTRUCTIONS - MONTAGEANLEITUNG

1

**DISASSEMBLY
DESMONTAJE**

A Tornillería original
Original screws

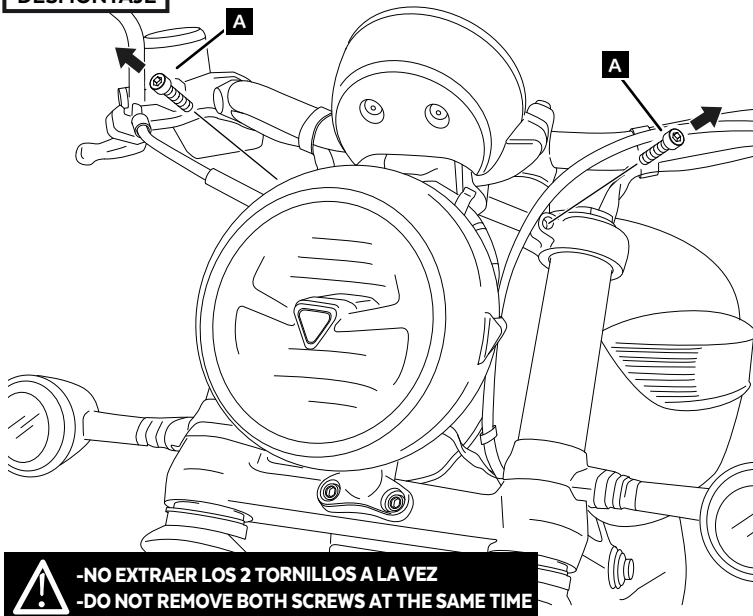

2

**ASSEMBLY
MONTAJE**

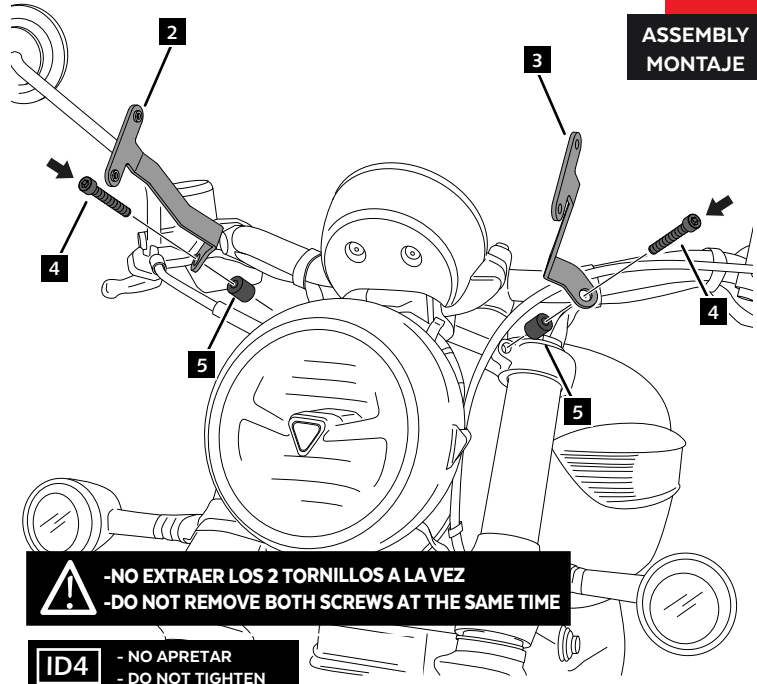

3

**ASSEMBLY
MONTAJE**

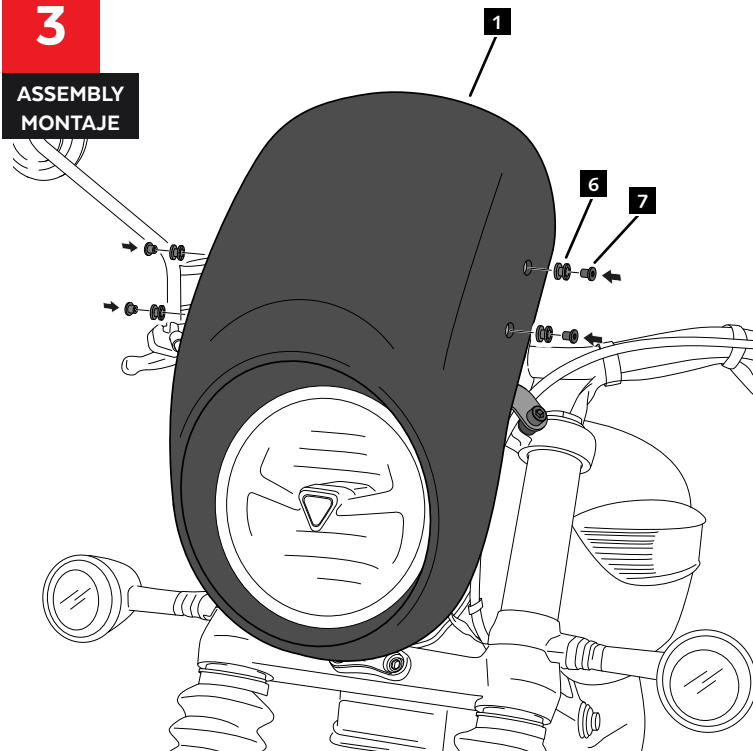

4

**ASSEMBLY
MONTAJE**

