

MOTOPLASTIC, S.A.

Molí de la sal, 1 - 08403 Granollers (Barcelona) SPAIN

Tel. 34 93 849 06 33 - Fax 34 93 849 09 88

info@puig.tv - info@puigusa.com

www.puig.tv - www.puigusa.com

## INSTRUCCIONES DE MONTAJE - MOUNTING INSTRUCTIONS - MONTAGEANLEITUNG

QUILLA ADAPTABLE A – ENGINE SPOILER FOR – BUGSPOILER FÜR

# SUZUKI GSR 750





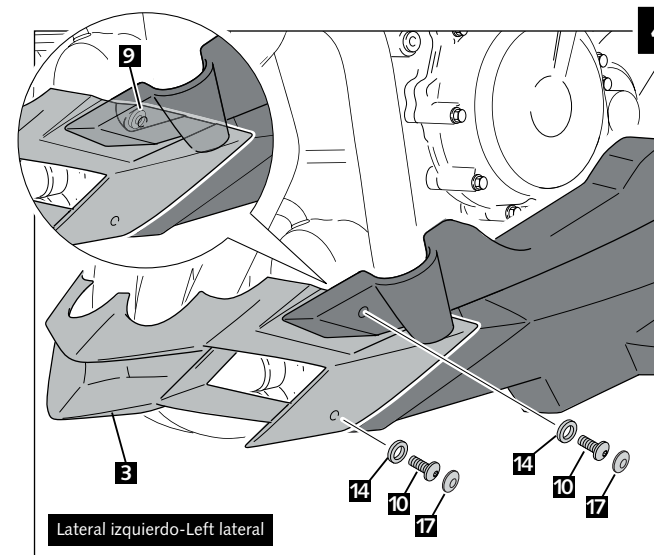
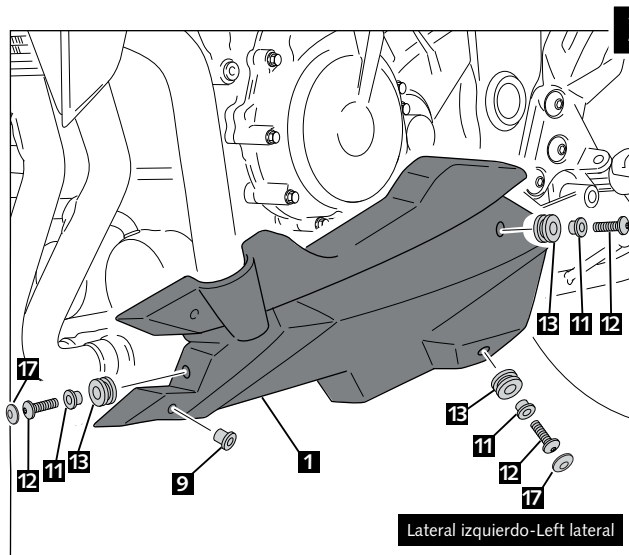
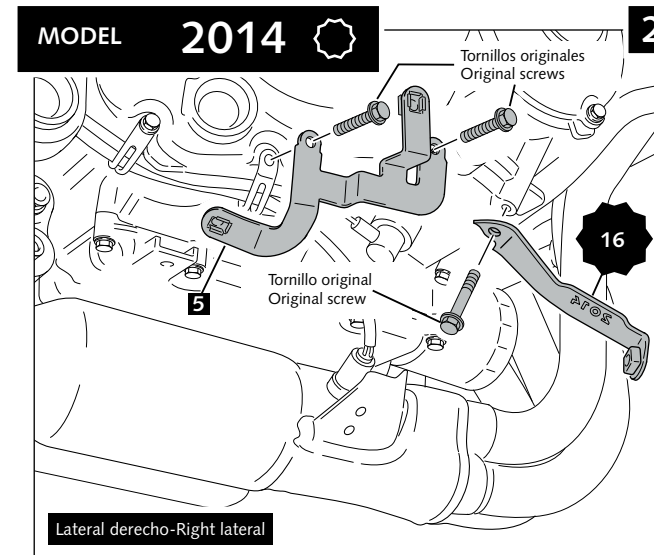
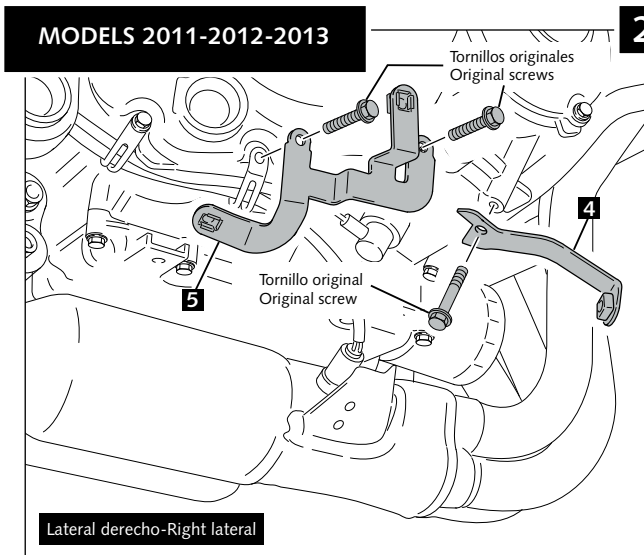
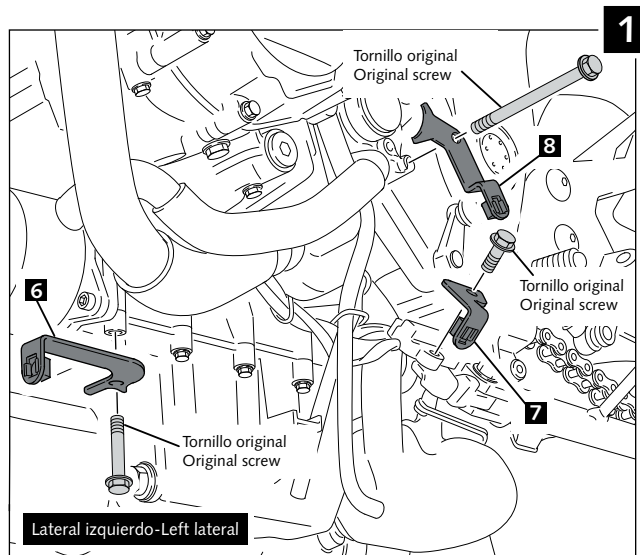











**Ref.: 5682J**  
(color negro/black colour)

**Ref.: 5682C**  
(color carbono/carbon look)



QUILLA ADAPTABLE A – ENGINE SPOILER FOR – BUGSPOILER FÜR  
**SUZUKI GSR 750**



ID.		DESCRIPCIÓN	DESCRIPTION	QTY.
1		Quilla derecha	Right engine spoiler	1
2		Quilla izquierda	Left engine spoiler	1
3		Quilla central	Central engine spoiler	1
4		Soporte metálico derecho delantero (MODELOS 2011-2012-2013)	Front right metal support (MODELS 2011-2012-2013)	1
5		Soporte metálico derecho trasero	Rear right metal support	1
6		Soporte metálico izquierdo delantero	Front left metal support	1
7		Soporte metálico izquierdo trasero inferior	Lower rear left metal support	1
8		Soporte metálico izquierdo trasero superior	Upper rear left metal support	1
9		Silemblock M6 (se suministra montado en la pieza nº1-2-3)	M6 well nut (supplied already mounted on the piece nº1-2-3)	4
10		Tornillo Allen M6x15 ISO 7380	M6x15 ISO 7380 Allen screw	4
11		Casquillo con valona	Bush with flange	6
12		Tornillo Allen M6x20 ISO 7380	M6x20 ISO 7380 Allen screw	6
13		Silemblock	Well nut	6
14		Arandela nylon	Nylon washer	4
15		Conjunto de adhesivos	Stickers set	1
16		Soporte metálico derecho delantero (MODELO 2014)	Front right metal support (MODEL 2014)	1
17		Tapón tornillo M6 ISO 7380	M6 ISO 7380 screw cap	8