

MOTOPLASTIC, S.A.

Molí de la sal, 1 - 08403 Granollers (Barcelona) SPAIN

Tel. 34 93 849 06 33 - Fax 34 93 849 09 88







info@puig.tv - info@puigusa.com

www.puig.tv - www.puigusa.com

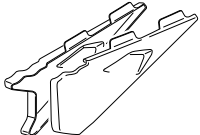
**Ref.: 7518**

## INSTRUCCIONES DE MONTAJE - MOUNTING INSTRUCTIONS - MONTAGEANLEITUNG

### TAPAS LATERALES ADAPTABLES A - INFILL PANELS ADAPTABLE TO BMW R1200GS ADVENTURE LC / R1250GS ADVENTURE

ID.	PIEZA / PART	DESCRIPCIÓN	DESCRIPTION	QTY.
1		Juego de tapas laterales	Infill panels	1
2		Soporte metálico derecho	Right metal support	1
3		Soporte metálico izquierdo	Left metal support	1
4		Silemblock Ø int. 9,6 Ø ext. 23x9	Silemblock Ø inner 9,6 Ø outer 23x9	4
5		Tornillo Allen M5x16 ISO 7380 cabota Ø9mm	M5x16 ISO 7380 Allen screw - Head Ø9mm	2
6		Silemblock M5	M5 Silemblock	2
7		PERFIL PVC 1048 negro autoadhesivo (se entrega montado)	Self-adhesive black PROFILE PVC 1048 (supplied mounted)	4

Created by: www.candissery.com

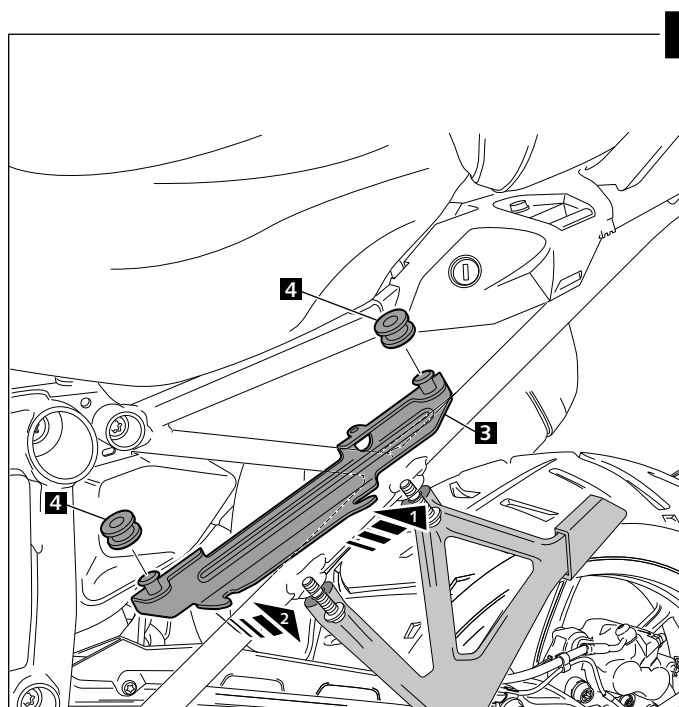
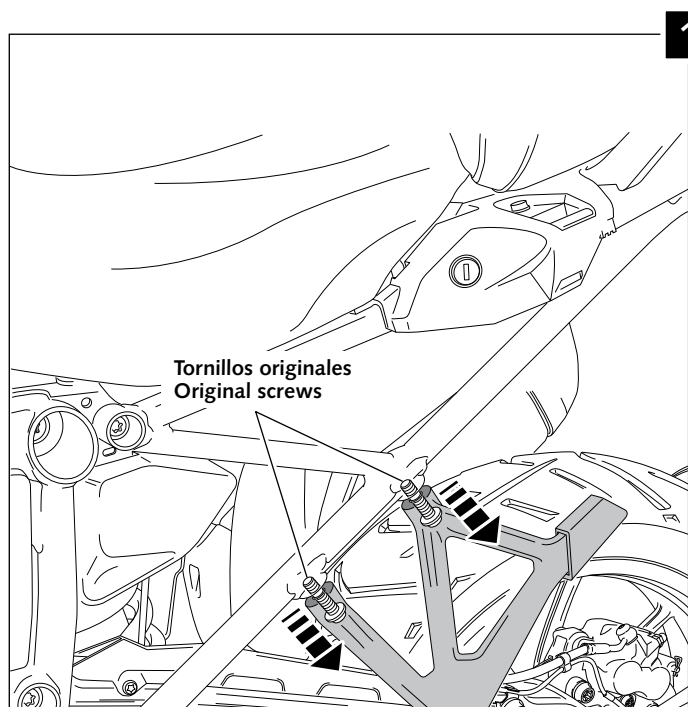

MOTOPLASTIC, S.A.

Molí de la sal, 1 - 08403 Granollers (Barcelona) SPAIN

Tel. 34 93 849 06 33 - Fax 34 93 849 09 88

info@puig.tv - info@puigusa.com

www.puig.tv - www.puigusa.com

## INSTRUCCIONES DE MONTAJE - MOUNTING INSTRUCTIONS - MONTAGEANLEITUNG

### TAPAS LATERALES ADAPTABLES A - INFILL PANELS ADAPTABLE TO BMW R1200GS ADVENTURE LC / R1250GS ADVENTURE

