

QUILLA ADAPTABLE A – ENGINE SPOILER FOR – BUGSPOILER FÜR  
**SUZUKI SV650 '99-'12 - DL650 V-STROM '04-'11**  
**SUZUKI SV650 '16**









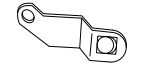
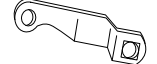

**Ref.: 8559J**  
 (color negro/black colour)

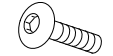

**Ref.: 8559C**  
 (color carbono/carbon look)



ID.		DESCRIPCIÓN	DESCRIPTION	QTY.
1		Quilla	Engine spoiler	1
2		Soporte anterior izquierdo con tuerca enjaulada M6	Front left support with and unside M6 nut	1
3		Soporte anterior derecho con tuerca enjaulada M6	Front right support with and unside M6 nut	1
4.1		Soporte posterior izquierdo con tuerca enjaulada M6 (SUZUKI SV650 '99-'12 / SUZUKI V-STROM '04-'11)	Rear left support with and unside M6 nut (SUZUKI SV650 '99-'12 / SUZUKI V-STROM '04-'11)	1
4.2		Soporte posterior izquierdo con tuerca enjaulada M6 (SUZUKI SV650'16)	Rear left support with and unside M6 nut (SUZUKI SV650 '16)	1
5		Soporte posterior derecho con tuerca enjaulada M6	Rear right support with and unside M6 nut	1
6		Tornillo Allen M6x20 DIN 1001	M6x20 DIN 1001 Allen screw	4
7		Silemblock Ø9Ø11xØ18 (se suministra montado en la pieza1)	Ø9Ø11xØ18 well nut (supplied already manted on the 1 piece)	4
8		Casquillo con valona (se suministra montado en la pieza 1)	Arrowhead with valona (supplied already manted on the 1 piece)	4
9		Kit adhesivos	Stikers set	4

QUILLA ADAPTABLE A – ENGINE SPOILER FOR – BUGSPOILER FÜR

## SUZUKI SV650 '99-'12 - DL650 V-STROM '04-'11 SUZUKI SV650 '16

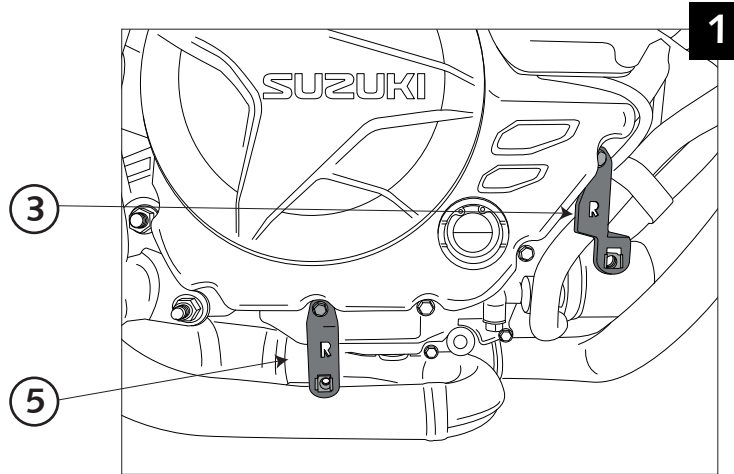

Soporte anterior y posterior,  
 parte derecha.  
 Front and rear right supports.

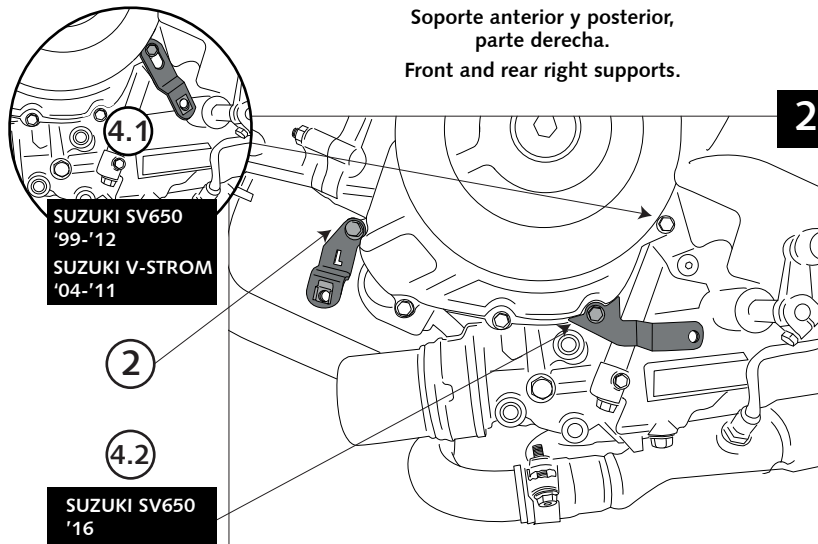

SUZUKI SV650  
 '99-'12  
 SUZUKI V-STROM  
 '04-'11

SUZUKI SV650  
 '16

Soportes anterior y posterior,  
 parte izquierda.  
 Front and rear left supports.

